

DEVICES COVERED IN THIS DOCUMENT:

- 45ET-EL Cylinder Escutcheon Lever Trim - Fail Safe
- 45ET-EU Cylinder Escutcheon Lever Trim - Fail Secure

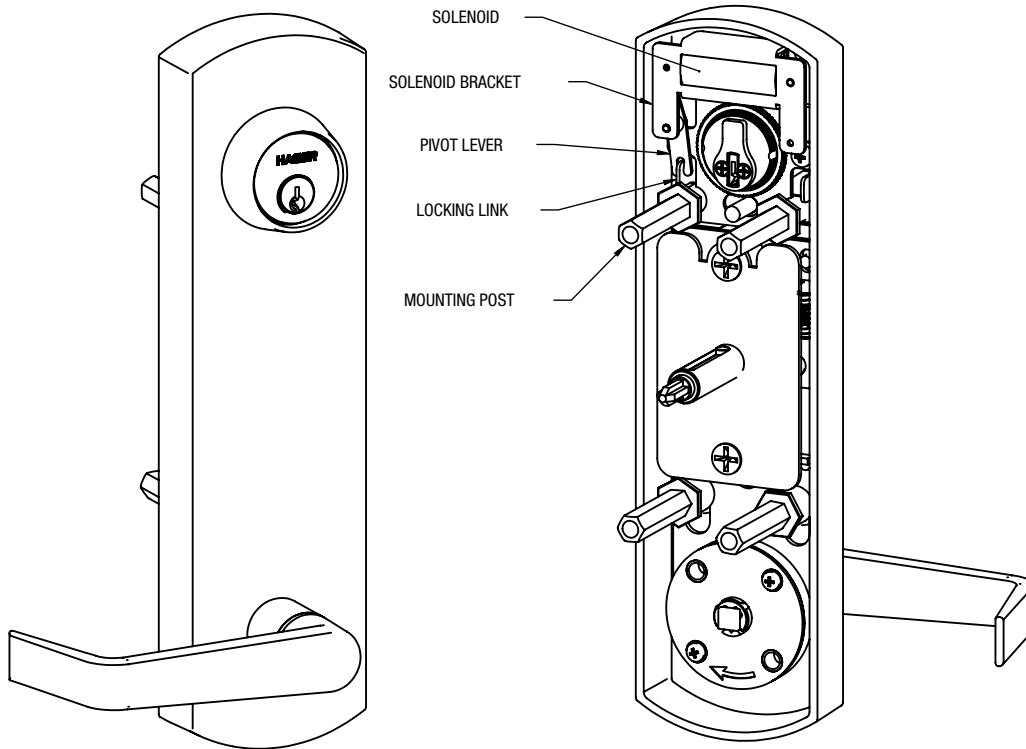

1. PREPARE DOOR

- A. Follow exit device instructions and template to prepare door and frame for installation.
- B. Follow lever trim instructions and special electric version of the trim template (see document T-ED00372) to prepare door for installation.
 - i. The electric trim template identifies the location of a 1/2" diameter hole through the door for wire transfer to exit device side of door. The wires are then routed through the exit device, into the door raceway to power transfer device (electric hinge).
 - ii. The wire transfer hole is handed, so be sure to use the correct location.
- C. Door fabricator to provide a 3/8" diameter (minimum) raceway through door to allow insertion of electrical wires running between exit device and power transfer device (electric hinge). See "Wire Routing and Door Prep Instructions" for 4500 Series Electric Exit Devices, document I-ED00367.

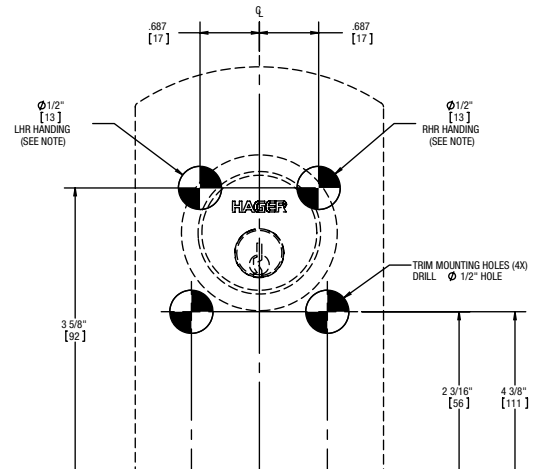

2. PREPARE EXIT DEVICE

- A. Remove four (4) screws from chassis cover and remove.
- B. Separate chassis/push bar from device body by removing two (2) screws located on chassis.
- C. After chassis/push bar has been removed from device body, insert cable assembly along the side of push bar. Make sure that connector end is located on the chassis side.
- D. After cable assembly has been routed on the side of the push bar, re-install the device body and secure with the two (2) screws.

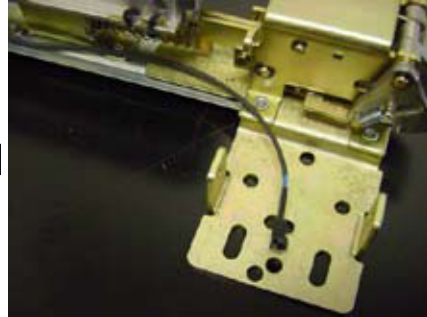
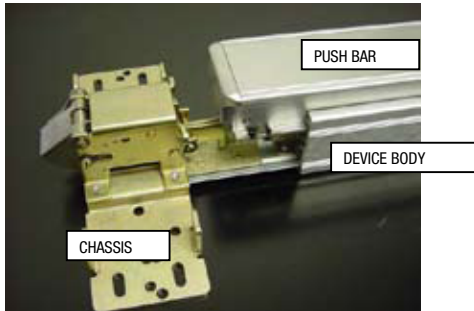

3. ROUTE CABLE

RIM Device

- A. Feed the connector on the trim control through the .500 diameter prep hole of door and through the slotted hole in RIM device chassis.
- B. Connect the cable assembly to the connector on the trim and finish mounting the devices per the manufacturers instructions.

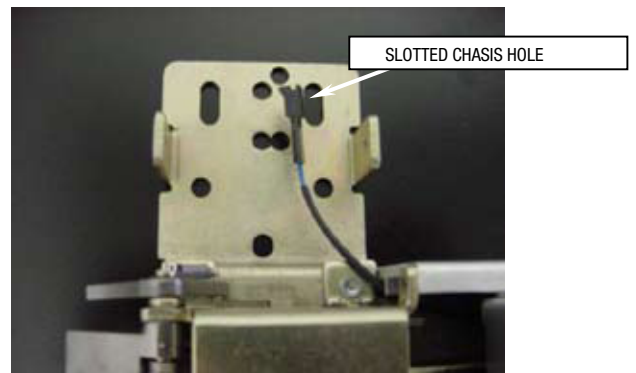

Conceal and Surface Vertical Rod Devices

- A. Feed the connector on the trim control through the .500 diameter prep hole of door and through the hole in surface vertical rod chassis.
- B. Connect the cable assembly to the connector on the trim and finish mounting the devices per the manufacturers instructions.

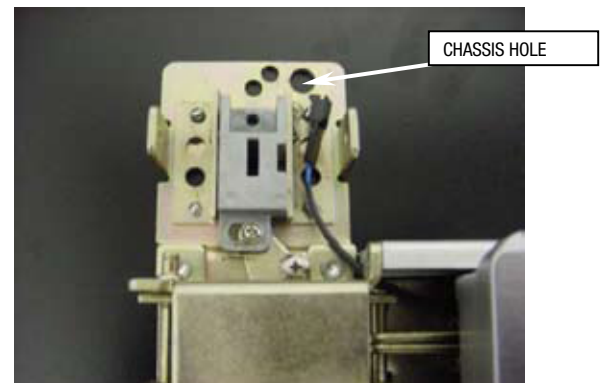

4. SECURE WIRES

- A. After the exit device and trim is mounted, secure the wires in the back of exit device body with the self-adhesive ty-wrap mount and ty-wrap.

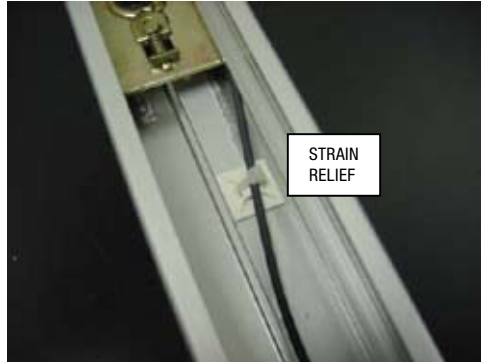

5. TERMINATE WIRE

- A. Terminate wire connections with appropriate crimp splices or wire nuts.

NOTE: It is helpful to stagger terminations. This allows for easy insertion of wires through prep holes.